

**Code**  
**W15133**

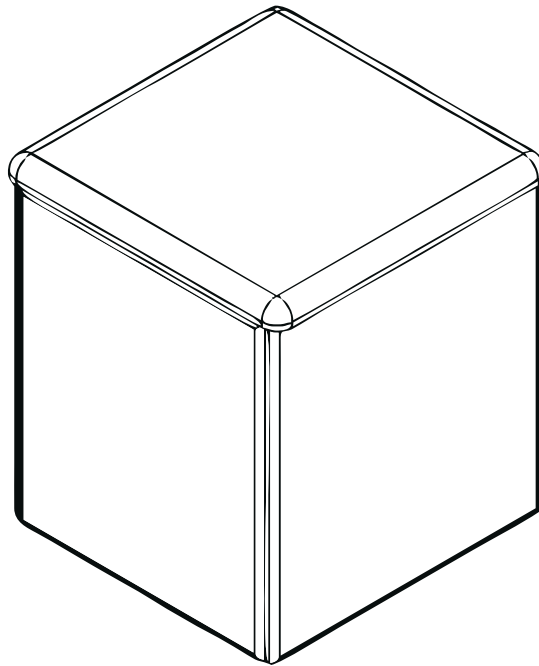

**LARGE SIZE BOX FOR COMBO CHAIR AND CADILLAC -  
PILATES LINE**



**INTERNATIONAL DISTRIBUTOR**  
*3B Scientific GmbH, Hamburg*  
*Rudorffweg 8*  
*21031 Hamburg*  
*www.3bscientific.com*

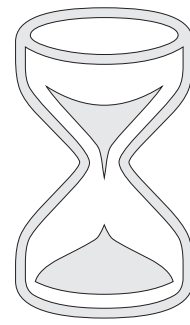
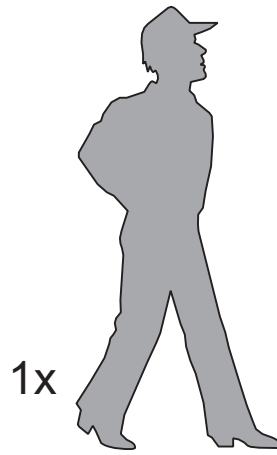
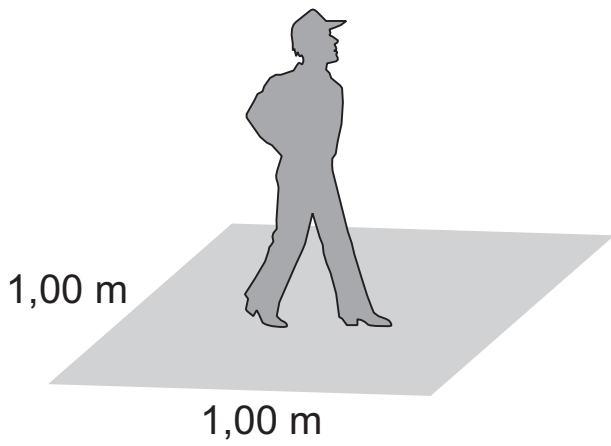

0 min.

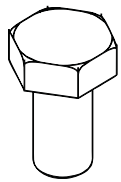

**A**  
**12x**

**Ø3/16" x 1/2"**

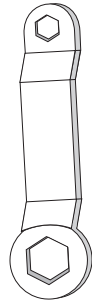

**B**  
**1x**

**Ø7/16" x 5/16"**

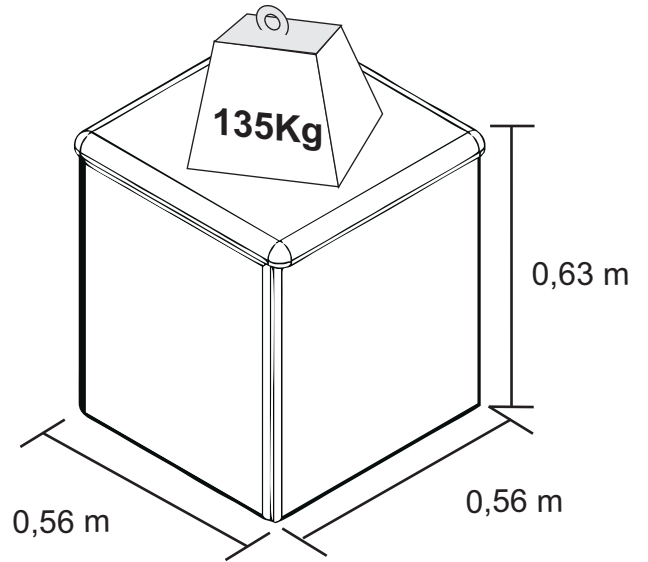

Weight 10,1 kg

